



**ESTACION OCHO SRL.**



**CATALOGO 2015**

**Calle Guarocuya #16, Ezq. Bohechio, Ens. Quisqueya;  
tels 809-368-2990**

**E-mail. [estacion8.cocinas@gmail.com](mailto:estacion8.cocinas@gmail.com) Santo Domingo, D.N**



# **NUUESTRO OBJETIVO ES PROPORCIONARLE UN ESPACIO PARA VIVIR CONFORTABLE Y CON ESTILO.**

## **INDICE:**

- PAG. 3 : DATOS DE EMPRESA**
- PAG. 4 : COCINAS LAMINADAS.**
- PAG. 9 : COCINAS LACADAS.**
- PAG. 15 : COCINAS DE MADERA.**
- PAG. 21: SERIE BAÑOS.**
- PAG. 25: COMPLEMENTOS DE COCINA.**
- PAG. 31: CLOSETS Y VESTIDORES.**
- PAG. 37: REVESTIMIENTOS DE MADERA.**



**ESTACION OCHO SRL** es una empresa con varios años de experiencia en Rep. Dominicana, dedicada a la importación, distribución y venta de muebles de cocina modular, closets, puertas, revestimientos de suelos, paredes en madera laminada y ventanales de aluminio.

**ESTACION OCHO** tiene un personal altamente especializado en los distintos productos, con varios años de experiencia en el mercado Dominicano, al igual que en el mercado Europeo. Por lo que ofrecemos una total garantía sobre nuestros trabajos, tanto en los materiales servidos como en su instalación. Además de ofrecer un servicio post-venta para dar una seguridad total a nuestros clientes del producto que han adquirido

**ESTACION OCHO** ha hecho una selección de los más importantes suplidores Europeos, los cuales garantizan una máxima calidad en los productos importados, pasando por los rigurosos controles de calidad de la Comunidad Económica Europea y garantizando una continuidad en la fabricación de dichos productos.



**OFREZCANOS UN ESPACIO  
Y LE DISEÑAREMOS  
SU SUEÑO**





# **COCINAS LAMINADAS 4 CANTOS**





**SERIE MAXIMA - OLIVE  
ALTO BRILLO ACRILICO**





# ARMONIA EN SUS LINEAS

SERIE NATUR - LINO





## SERIE MAXIMA COLORES LISOS



## SERIE MAXIMA DISEÑOS



La serie MAXIMA esta hecha con base de MDF de 18 mm.  
Los colores lisos también pertenecen a la serie PREMIUN de 22mm.  
Estas dos series son en Alto Brillo Acrílico (Brillo Cristal).

## SERIE GM COLORES LISOS



La serie GM esta hecha con laminado Alta Presión Brillo

## SERIE NATURMEL LAMINADO DISEÑOS EN MADERA MATE



## DIVERSIDAD DE CANTOS EN LAS PUERTAS

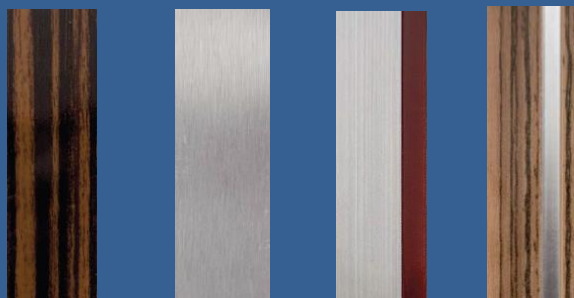

Diseño – Aluminio – Aluminio y Diseño – 3D





# **COCINAS LACADAS**

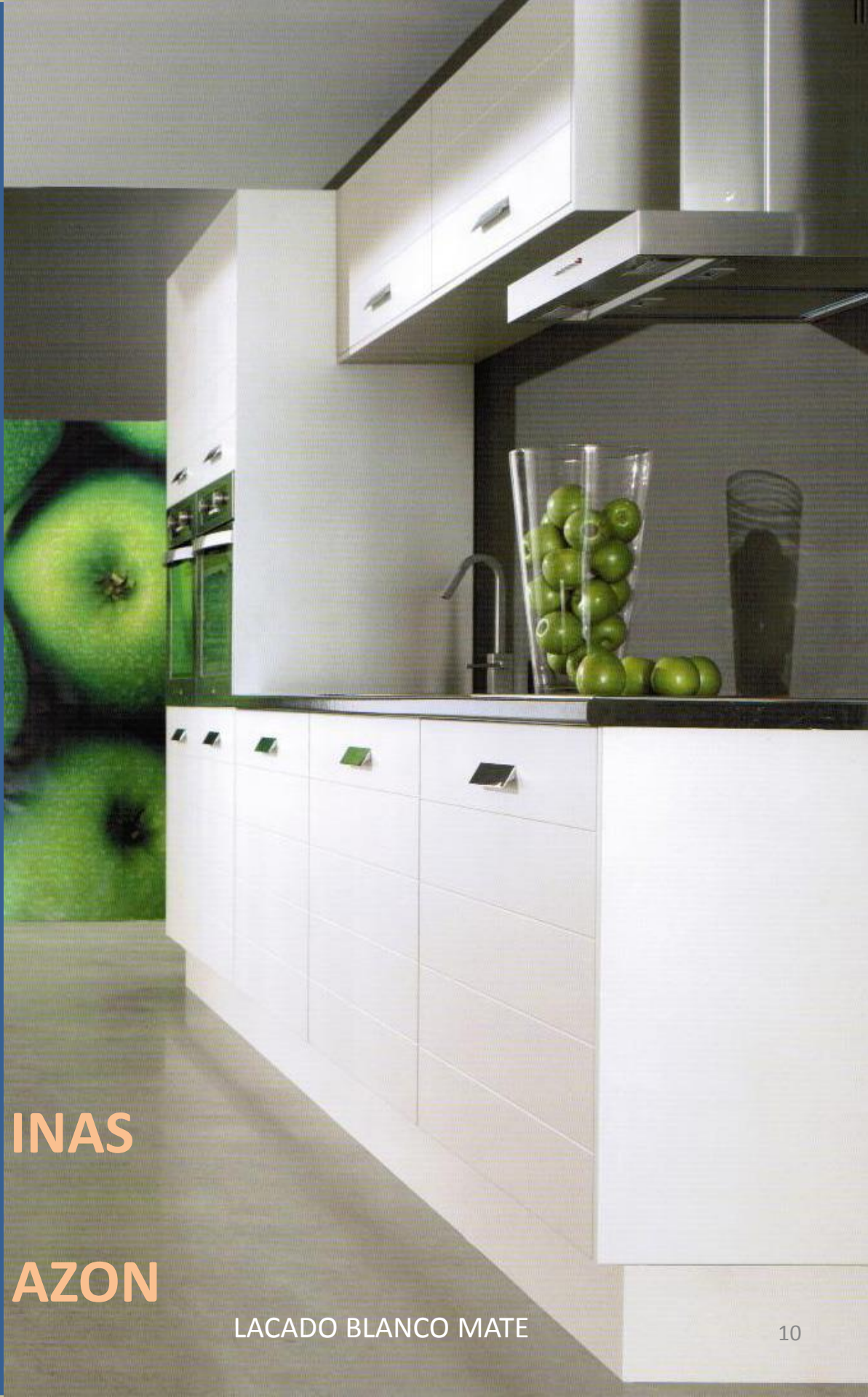

**COCINAS  
CON  
CORAZON**

LACADO BLANCO MATE



LACADA ALTO BRILLO  
MODELO MADRID 22 MM

# DISTINCION Y DISEÑO

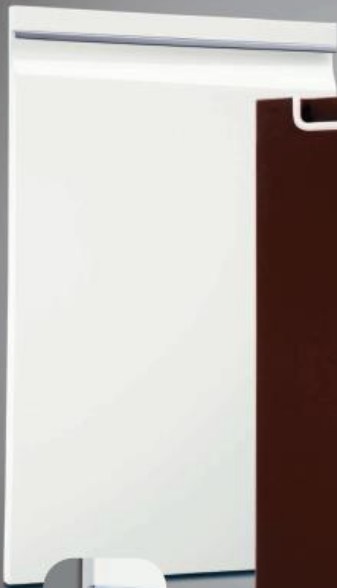

venus blanco brillo perfil cromado  
22mm x 22mm

www.3r



venus chocolate brillo perfil cromado  
22mm x 22mm

www.3r



palma blanco rojo brillo

www.3r

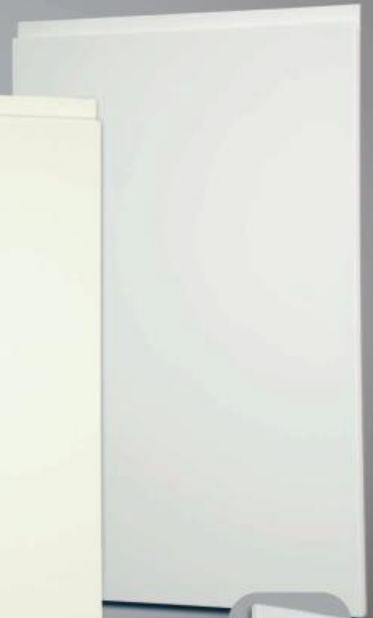

palencia blanco brillo  
22mm x 22mm

www.3r



# GAMA DE COLORES Y ACABADOS LACADOS

Los acabados son:

BRILLO – BRILLO MULTIPUNTO - MATE – SATINADO  
TEXTURADO – RUSTICO.

Los colores además de los que se ven son:

ALUMINIO – ARENA – AZUL ARMENIO – AZUL MARINO  
BEIGE – BERENGENA – BLANCO – BOURDEOS – COBRE  
CHOCOLATE – COBRE – GRAFITO – GRANATE – GRIS – LILA  
NARANJA – NEGRO – NUBE – ORO – PIZARRA – PLATA  
ROJO – TIERRA – TINTO – VAINILLA – VERDE AZULADO  
VERDE BOTELLA – VERDE MANZANA – VULCANO

Se puede hacer otros colores a petición del cliente con un  
Incremento en el precio del 25%

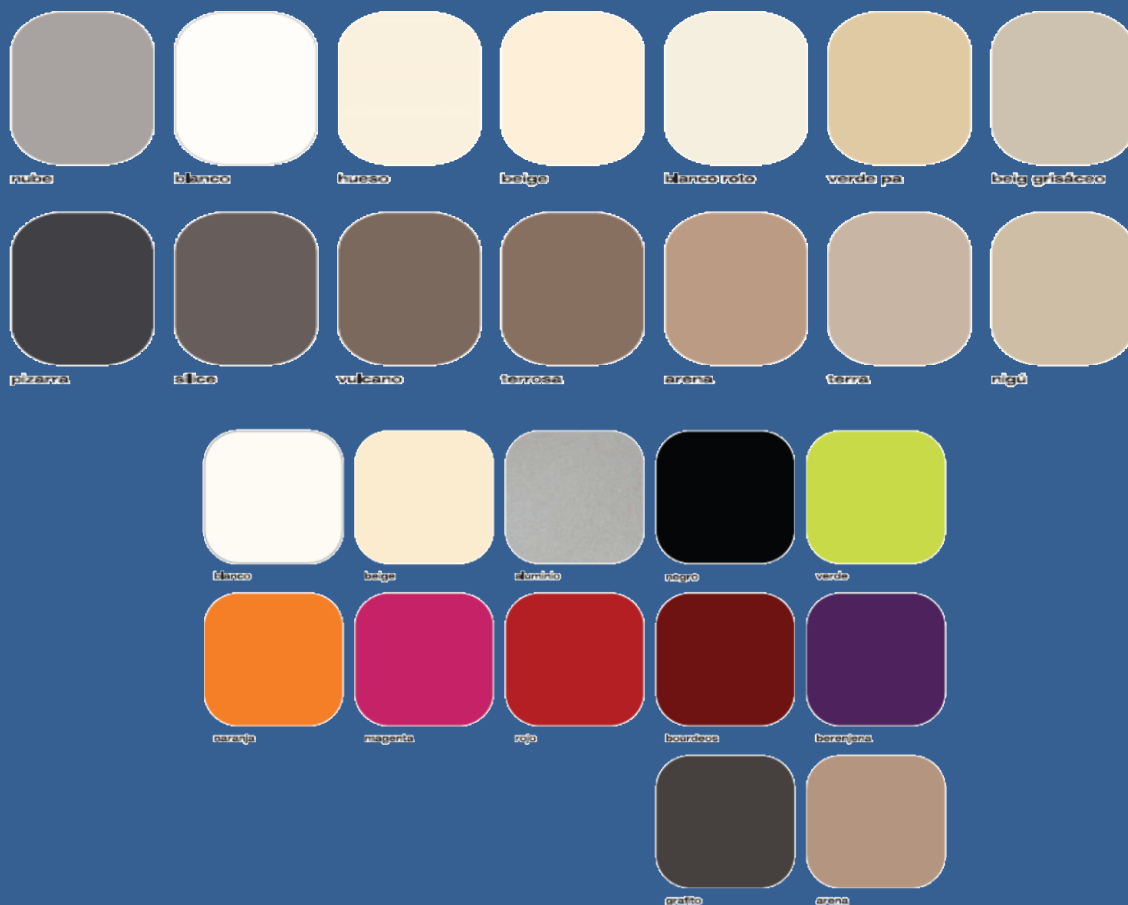





**COCINAS EN  
POLILAMINADO**



**ARMONIA EN**  
**SUS LINEAS**



sarajevo f62 wangué diseño  
vapa horizontal



sarajevo f60 berencena diseño  
vapa horizontal



corozo 10 mm.



roble 10 mm.



wangué 10 mm.



haya 10 mm.



roble 10 mm.



áramida 10/22 mm.



blanco 10/22 mm.



# **COCINAS DE MADERA NATURAL**





**ELEGANCIA Y**

**DISTINCION**



Se puede suministrar, cualquier tipo de complementos en madera, cornisa, regleta porta luz, vidrieras, campanas de madera, etc.

**DISPONEMOS DE CUALQUIER TIPO DE MADERA.**

# SERIE BAÑOS



UNA SOLUCION

PARA CADA ESPACIO





# DISEÑOS SENCILLOS Y ELEGANTES



**SE PUEDEN FABRICAR EN CUALQUIER DISEÑO  
DE LOS EXPUESTOS EN LAS COCINAS**





# **EQUIPAMIENTOS Y COMPLEMENTOS DE COCINA**







# HERRAJES Y COMPLEMENTOS BASICOS

## CAJONES DE AUTORRETENCION

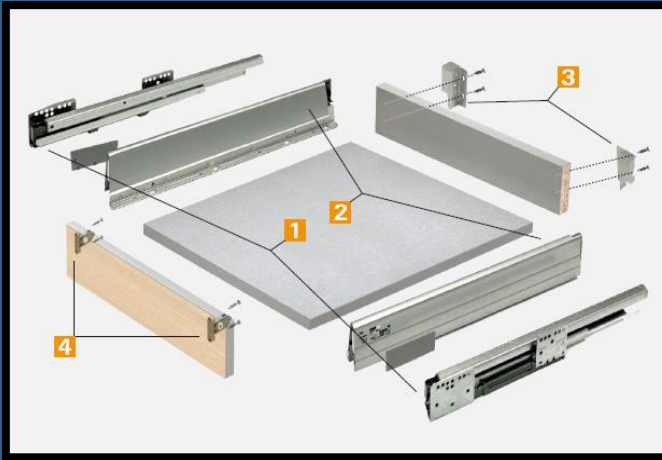

## BISAGRAS DE AUTORRETENCION



## CUBERTEROS PLASTICOS



## PROTECTOR DE FREGEDERO

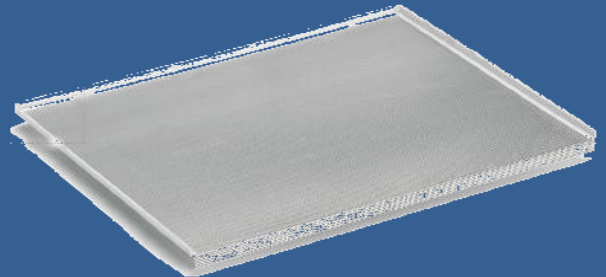

## ESCURREPLATOS DE ACERO INOXIDABLE

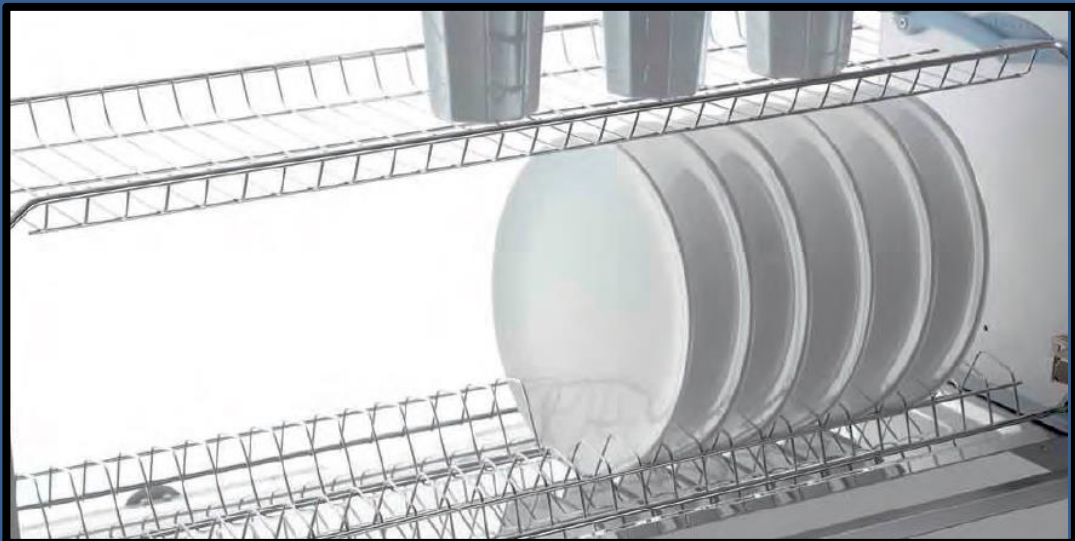

## SISTEMAS PARA DESPENSAS



## SISTEMAS DIVERSOS PARA RINCONEROS





## **SISTEMAS ETOUCH**

**Disponemos de sistemas  
TOUCH CONTROL**

**Un suave toque frontal a  
la superficie de la puerta,  
es suficiente para la  
apertura que abra la  
puerta y la guía de la  
dispensa abre de forma  
segura incluso con  
máxima carga. (sistema  
electrónico)**



## **TOUCH CONTROL PARA CAJONES**

**También disponemos de sistema electrónico de cajones.  
Con un suave toque en el frontal del cajón, se abre  
suavemente**



# CLOSETS EMPOTRADOS







## SISTEMA DE FRENADO EN LAS PUERTAS



# INTERIORISMO DE CLOSETS



PANTALONEROS EXTENSIBLES

ZAPATEROS EXTENSIBLES



COLGADORES DE PERCHAS ABATIBLES



# PUERTAS CORREDERAS - DESPIECE

SLIDING DOORS - SPARES

PORTES GLISSANTES - DÉPIÈGE

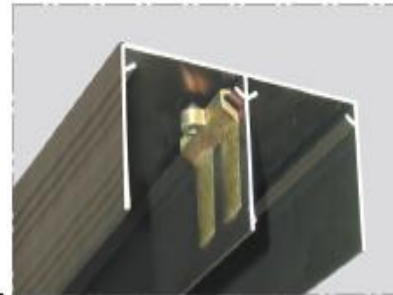
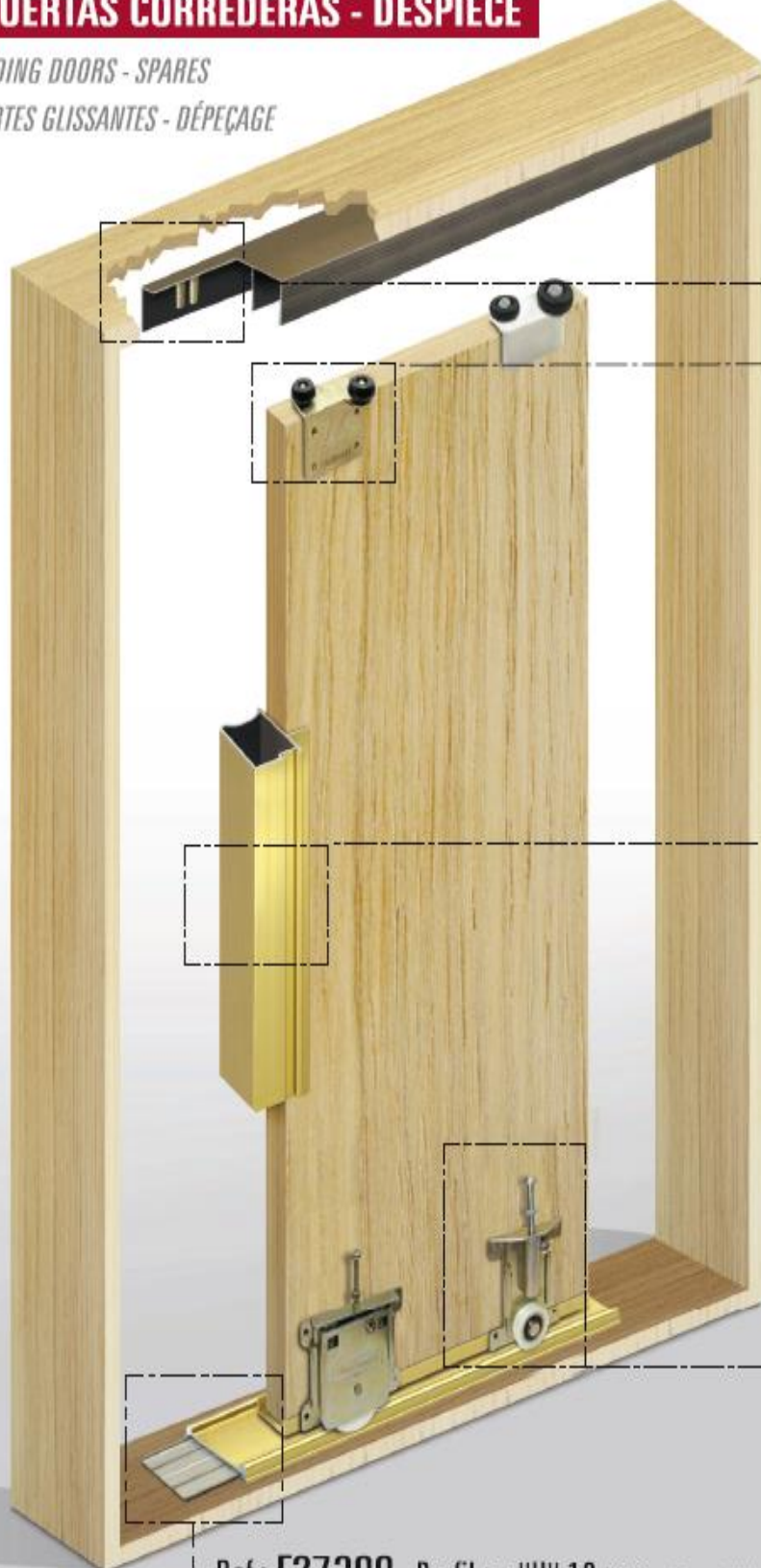

Freno *Zamak brake / Frein* Ref.: F27805



Carro superior Ref.: F27804  
*Zamak upper sliding system wheel / Glissière supérieure*

Perfil tirador 16 mm. Ref.: F27000

*16 mm. handle profile / Poignée 16 mm.*



Carro inferior Ref.: F27803

*Bottom sliding system wheel / Glissière inférieure*

Ref.: F27300 Perfil en "U" 16 mm. *16 mm. "U" profile / Profil "U"*

Ref.: F27500 Guía inferior *Lower profile / Guide inférieure*

Ref.: F27650 Perfil base para guía inferior

*Lower profil base / Base pour la guida supérieure*

